



HUIGONG BEARING





Company profile

Luoyang Huigong Bearing Technology Co., Ltd (CHG) is an enterprise majored in research , development, production and sales of accuracy bearings. According to the needs of users, the company has developed high-accuracy, high-performance, high-quality crossed roller bearings used on industrial robots. The company can produce HRA, HRB, HRE, HRU series of crossed cylindrical roller bearings and HXR series of crossed tapered roller bearings with the accuracy of Grade P2. The products are widely used in industrial robots, CNC machine tools, reducers, printing machinery, medical equipment, accuracy measurement and control equipment, communication radar antennas, optical equipment, and etc.

Adhering to the concept of “Collect Elites and Develop Boutique” , our company is committed to providing customers with high quality products. CHG has a technical team with more than ten years of research and development experiences for bearings, and they have achieved the outstanding results and many patents in design, manufacture and detection of uniform-section thin-section bearings, thin-section crossed roller bearings, large accuracy high-speed ball bearings and other accuracy bearings. The company always focuses on the modern management model, and has passed the certification of ISO9001: 2008 quality management system. According to customer requirements, our products can be tested by SGS, ASIA or other third-party international testing organizations.

“Collect Elites and Develop Boutique” is an eternal theme held by CHG. The company will continue to provide the highest quality products and the most complete services for customers around the world through technological innovation.

Table of Contents

Crossed cylindrical roller bearings

1、Features of crossed cylindrical roller bearings	2
2、Types of crossed cylindrical roller bearing s	3
3、Selection of crossed cylindrical roller bearings	4
4、Design and mounting of crossed roller bearing	6
5、Mounting and fitting of crossed cylindrical roller bearing	14
6、HRA crossed cylindrical roller bearing	18
7、HRB crossed cylindrical roller bearing	19
8、HRE crossed cylindrical roller bearing	22
9、HRU crossed cylindrical roller bearing	25
10、List of HRU series of products	28

Crossed tapered roller bearing

1、Structure and characteristics of crossed tapered roller bearing	26
2、Applications	26
2、Design and structural characteristics	26

Application fields	28
--------------------	----

Crossed roller bearings applied in the robot industry	29
---	----

Features of crossed cylindrical roller bearings

Structural features

The crossed cylindrical roller bearing is a bearing with cylindrical rollers cross-arranged vertically between the inner and outer rings, there is a line contact between the roller and the raceway, with a high rigidity and very small elastic deformation under any load, and it can carry radial load, axial load and moment load at the same time, so it is especially suitable for applications with the requirements of high rigidity and rotation accuracy.

The sizes of inner and outer rings are minimized; the sizes of ultra-thin type are close to the limit sizes, and it has a high rigidity, to simplify the bearing structure in the design, so it is especially suitable for applications for joints or rotating portions of industrial robots, the rotary benches of machining centers, manipulator rotation portions, accuracy rotary tables, medical equipment, measuring equipment, IC manufacturing equipment and etc.

Rotation accuracy

There are spacer retainers among the rollers arranged vertically in the bearing, which can prevent the roller inclination and the friction among the rollers, and reduce the friction torque; in addition, compared to the previously used steel cage, the roller contact or locking phenomenon at one side can be avoided; furthermore, because its inner (or outer) ring is a two-divided structure, and the bearing clearance can be adjusted, the high accuracy rotation movement can be achieved, even if the preload is applied.

Use features

After the rollers and spacer retainers are installed, the two-divided inner (or outer) ring is secured together with the cross roller shaft ring, to prevent separation from each other, so its mounting is easy. The use of the spacer retainers can avoid the friction among the rollers and prevent the roller inclination, so as to obtain a stable rotation torque. Since the rollers are staggered, only a crossed roller bearing assembly can carry loads in all directions, its rigidity can be increased by 3 ~ 4 times compared with conventional type.



Types of Crossed cylindrical roller bearing

(1) HRA series (two-divided outer ring, rotation inner ring, ultra-thin type)

This series is the compact HRB type of crossed cylindrical roller bearings with limit thickness of inner and outer rings. As HRB series, they have a two-divided outer ring, and are especially suitable for applications with weight reduction, compact design, and high rotation accuracy of inner ring, such as rotating portions of the robots.

(2) HRB series (two-divided outer ring and integrated inner ring)

This series is a basic type of crossed roller bearings. The outer ring is divided into two halves and the inner ring is an integrated ring; it is especially suitable for applications with high rotation accuracy of inner ring.

(3) HRE series (two-divided inner ring and integrated outer ring)

This series is a basic type of crossed roller bearings, with the same sizes as HRB type. The inner ring is divided into two halves and the outer ring is an integrated ring; it is especially suitable for applications with high rotation accuracy of outer ring.

(4) HRU series (integrated inner and outer rings, high rigidity, with mounting holes)

Because there are mounting holes on the outer and inner rings, the mounting flange and the support base are not required during mounting of these series of bearings. In addition, since the outer and inner rings are integrated structures, the mounting is virtually no impact on its performance, and the stable rotation accuracy and torque can be obtained. They are especially suitable for application with rotation of outer and inner rings.



Selection of crossed roller bearing

Example of crossed roller bearings selection

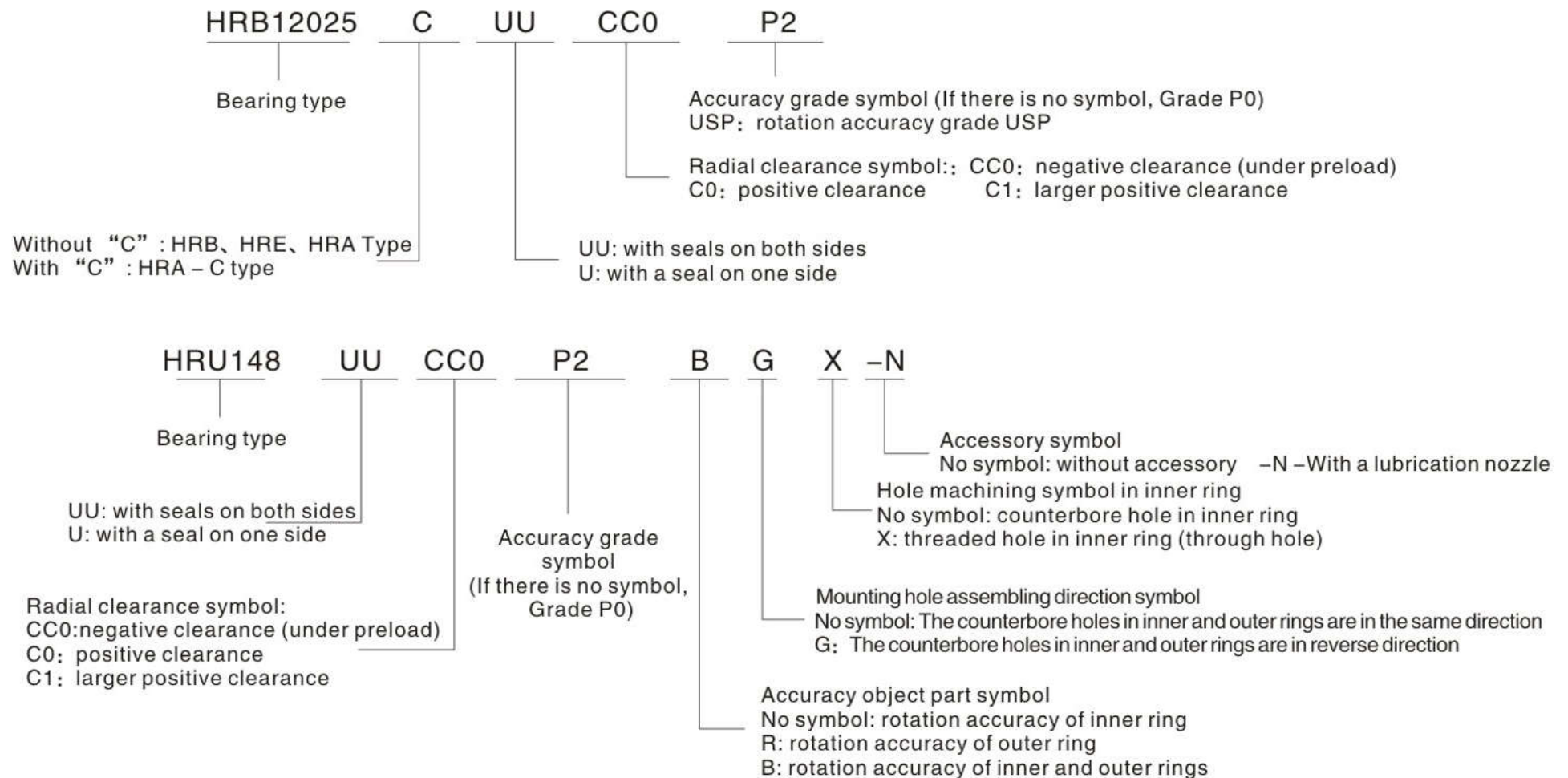

Principles for crossed roller bearing selection:

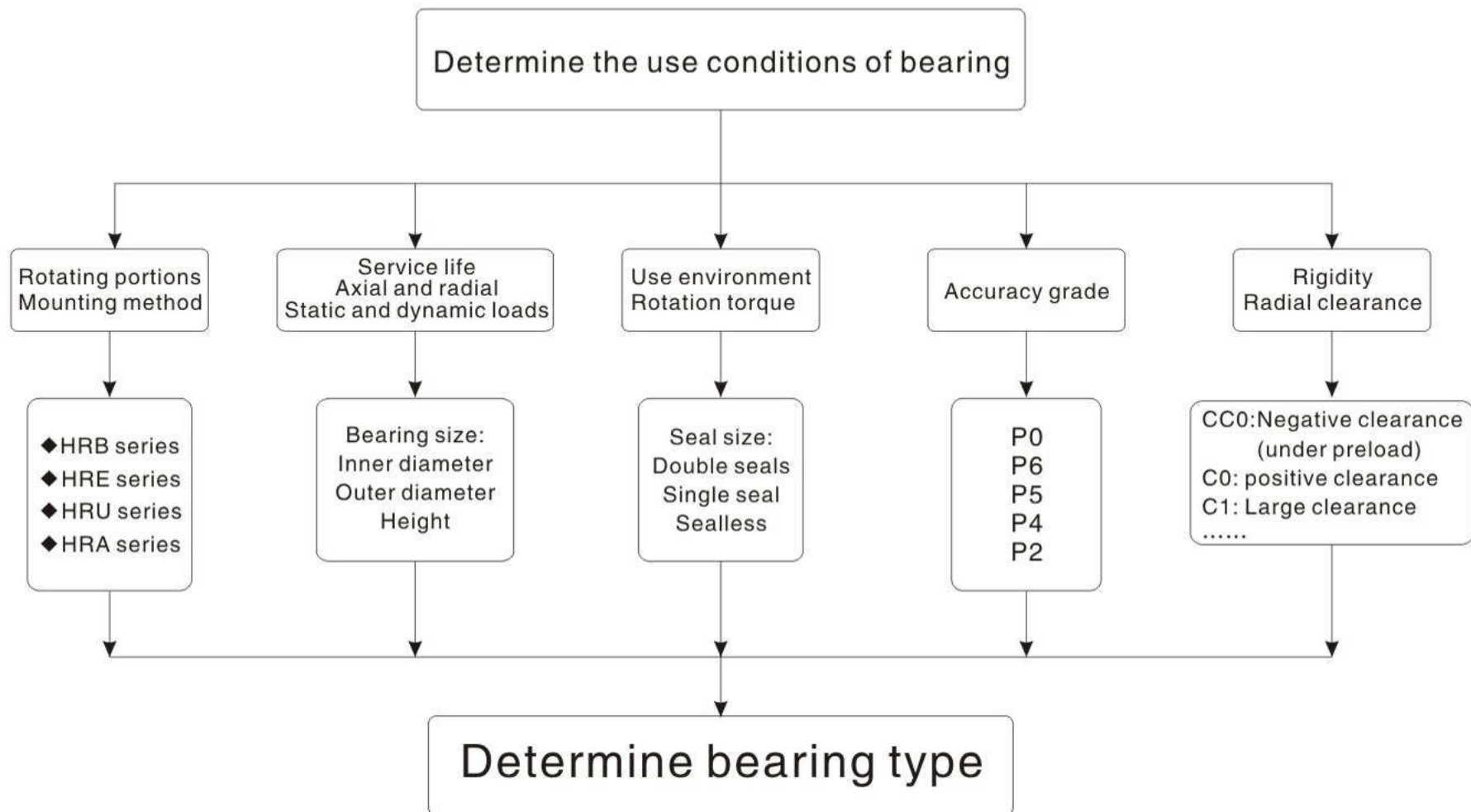

Design and mounting of crossed roller bearing

Basic rated life

The basic rated life refers to the total number of revolutions of a batch of bearings operated under the same conditions and 90% of them are no flaked due to the rolling fatigue. The basic rated life of bearing under a fixed load can be calculated with the formula as follows:

$$L = \left(\frac{C}{P} \right)^{\frac{10}{3}} \times 10^6$$

Where: L – Basic rated life of the bearing (number of revolutions); P – Equivalent dynamic load (N)
C – Basic rated dynamic load (see values in the size table) (N).

When the bearing is operated under a composite of radial load, axial load and overturning moments, these loads and moments can be integrated into one load applied on the bearing center, which is referred as the equivalent dynamic load P, with the formula as follows:

$$P = X \left(F_r + \frac{2M}{D_{pw}} \right) + Y F_a$$

F_r — Radial load F_a —Axial load

M —Moment, Unit: N · mm

X and Y are radial and axial load factors* for the specific data, ※Please contact us

$$D_{pw} - \text{Pitch circle diameter} = \frac{\text{Bearing inner diameter } d + \text{Bearing outer diameter } D}{2} \text{ (mm)}$$

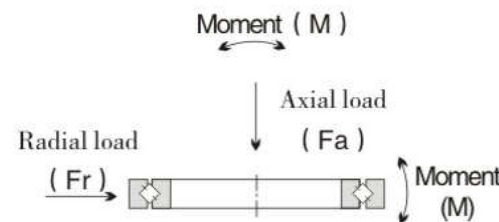

However, the actual life of crossed roller bearings is related to the bearing selection, material, structure, process quality, surrounding design and operation environment, mounting and maintenance. The fatigue failure is not the main failure mode of crossed roller bearing. Because the crossed roller bearing has a high rotation accuracy, the wear of rolling elements, raceway, or cage can decrease its accuracy (produce the axial and radial clearance) or other non-normal damages, but at this time there may be no fatigue failure on the bearing damage. So, the basic rated life is only as a reference data for the service life of crossed roller bearing.

Static load safety factor

Under the composite of radial load, axial load and overturning moment applied on the bearing, the rolling elements and the raceway may produce a permanent deformation under the maximum load, it is assumed there is an equal amount of permanent deformation of the bearing under the load, this assumed load is referred as the equivalent static load, with the formula as follows:

$$P_0 = F_r + \frac{2M}{D_{pw}} + 0.44 F_a$$

Where: P_0 — Equivalent static load; F_r — Radial load; F_a — Axial load; M —torque (N.mm)
Pitch circle diameter $D_{pw} = \frac{\text{Bearing inner diameter } d + \text{Bearing outer diameter } D}{2}$ (mm)

Safety factor

Safety factor (f_s) is mainly determined with the basic rated static load (C_0) and the equivalent static load (P_0), with the formula as follows:

$$f_s = \frac{C_0}{P_0}$$

Where, C_0 – Basic rated static load (N/KN); P_0 – Equivalent static load (N/KN);

The safety factor can be selected within the range of 1.5~3.5 based on different operation conditions, as show in the right figure:

Use conditions	Safety factor
Standard	≥1.5
Vibration environment	≥2
High speed and high accuracy	≥3.5

HRB Type

Table 1 Running accuracy of inner ring

 μm

Bearing inner diameter (d/mm)		Inner ring radial runout					Inner ring axial runout				
Exceed	To	P0	P6	P5	P4	P2	P0	P6	P5	P4	P2
18	30	13	8	4	3	2.5	13	8	4	3	2.5
30	50	15	10	5	4	2.5	15	10	5	4	2.5
50	80	20	10	5	4	2.5	20	10	5	4	2.5
80	120	25	13	6	5	2.5	25	13	6	5	2.5
120	150	30	18	8	6	2.5	30	18	8	6	2.5
150	180	30	18	8	6	5	30	18	8	6	5
180	250	40	20	10	8	5	40	20	10	8	5
250	315	50	25	13	10	—	50	25	13	10	—
315	400	60	30	15	12	—	60	30	15	12	—
400	500	65	35	18	14	—	65	35	18	14	—
500	630	70	40	20	16	—	70	40	20	16	—
630	800	80	—	—	—	—	80	—	—	—	—
800	1000	90	—	—	—	—	90	—	—	—	—
1000	1250	100	—	—	—	—	100	—	—	—	—

HRE Type

Table 2 Running accuracy of inner ring

μm

Bearing inner diameter (d/mm)		Inner ring radial runout					Inner ring axial runout				
Exceed	To	P0	P6	P5	P4	P2	P0	P6	P5	P4	P2
30	50	20	10	7	5	2.5	20	10	7	5	2.5
50	80	25	13	8	5	4	25	13	8	5	4
80	120	35	18	10	6	5	35	18	10	6	5
120	150	40	20	11	7	5	40	20	11	7	5
150	180	45	23	13	8	5	45	23	13	8	5
180	250	50	25	15	10	7	50	25	15	10	7
250	315	60	30	18	11	7	60	30	18	11	7
315	400	70	35	20	13	8	70	35	20	13	8
400	500	80	40	23	15	—	80	40	23	15	—
500	630	100	50	25	16	—	100	50	25	16	—
630	800	120	60	30	20	—	120	60	30	20	—
800	1000	120	75	—	—	—	120	75	—	—	—
1000	1250	120	—	—	—	—	120	—	—	—	—
1250	1600	120	—	—	—	—	120	—	—	—	—

HRU Type

Table 3 Running accuracy of inner ring

Normal type	Inner ring radial runout			Inner ring axial runout		
	P5	P4	P2	P5	P4	P2
HRU42	4	3	2.5	4	3	2.5
HRU66	5	4	2.5	5	4	2.5
HRU85	5	4	2.5	5	4	2.5
HRU124	5	4	2.5	5	4	2.5
HRU148	6	5	2.5	6	5	2.5
HRU178	6	5	2.5	6	5	2.5
HRU228	8	6	5	8	6	5
HRU297	10	8	5	10	8	5
HRU445	15	12	7	15	12	7

Table 4 Running accuracy of outer ring

Normal type	Outer ring radial runout			Outer ring axial runout		
	P5	P4	P2	P5	P4	P2
HRU42	8	5	4	8	5	4
HRU66	10	6	5	10	6	5
HRU85	10	6	5	10	6	5
HRU124	13	8	5	13	8	5
HRU148	15	10	5	15	10	5
HRU178	15	10	7	15	10	7
HRU228	18	11	7	18	11	7
HRU297	20	13	8	20	13	8
HRU445	25	16	10	25	16	10

※ For HRU type, P5 is its standard running accuracy

HRA Type

Table 5 Running accuracy of inner ring

Bearing inner diameter (d/mm)		Radial runout /axial runout
Exceed	To	
40	65	13
65	80	15
80	100	15
100	120	20
120	140	25
140	180	25
180	200	30

※ For HRA type of products with higher running accuracy, please contact us.

HRB、HRE Type

Table 6 Bearing inner diameter tolerances

μm

Bearing inner diameter (d) (d/mm)		Bearing inner diameter tolerances(d)							
		P0		P6		P5		P4、P2	
Exceed	To	Upper	Low	Upper	Low	Upper	Low	Upper	Low
18	30	0	-10	0	-8	0	-6	0	-5
30	50	0	-12	0	-10	0	-8	0	-6
50	80	0	-15	0	-12	0	-9	0	-7
80	120	0	-20	0	-15	0	-10	0	-8
120	150	0	-25	0	-18	0	-13	0	-10
150	180	0	-25	0	-18	0	-13	0	-10
180	250	0	-30	0	-22	0	-15	0	-12
250	315	0	-35	0	-25	0	-18	—	—
315	400	0	-40	0	-30	0	-23	—	—
400	500	0	-45	0	-35	—	—	—	—
500	630	0	-50	0	-40	—	—	—	—
630	800	0	-75	—	—	—	—	—	—
800	1000	0	-100	—	—	—	—	—	—
1000	1250	0	-125	—	—	—	—	—	—

*The standard inner diameter tolerances of HRA and HRU types should be Grade 0, for the products with higher diameter tolerance grade, please contact us.

*There is no indication of the bearing inner diameter accuracy grade in the table represents Grade , applying to the highest values in the following accuracy grade.

HRB、HRE Type

Table 7 Bearing outer diameter tolerances

μm

Bearing outer diameter (d/mm)		Bearing outer diameter tolerances (D)							
		P0		P6		P5		P4, P2	
Exceed	To	Upper	Low	Upper	Low	Upper	Low	Upper	Low
30	50	0	-11	0	-9	0	-7	0	-6
50	80	0	-13	0	-11	0	-9	0	-7
80	120	0	-15	0	-13	0	-10	0	-8
120	150	0	-18	0	-15	0	-11	0	-9
150	180	0	-25	0	-18	0	-13	0	-10
180	250	0	-30	0	-20	0	-15	0	-11
250	315	0	-35	0	-25	0	-18	0	-13
315	400	0	-40	0	-28	0	-20	0	-15
400	500	0	-45	0	-33	0	-23	—	—
500	630	0	-50	0	-38	—	-28	—	—
630	800	0	-75	0	-45	—	-35	—	—
800	1000	0	-100	—	—	—	—	—	—
1000	1250	0	-125	—	—	—	—	—	—
1250	1600	0	-160	—	—	—	—	—	—

- ※ The standard outer diameter tolerances of HRA and HRU types should be Grade 0, for the products with higher outer diameter tolerance grade, please contact us.
- ※ There is no indication of the bearing outer diameter accuracy grade in the table represents Grade, applying to the highest values in the following accuracy grade.

HRB、HRE Type

Table 8 Width tolerances of inner and outer rings (for all grades)

Bearing inner diameter (d/mm)		B		B1	
		Suitable for inner ring of HRB type and outer ring of HRE type		Suitable for outer ring of HRB type and inner ring of HRE type	
Exceed	To	Upper	Low	Upper	Low
18	30	0	-75	0	-100
30	50	0	-75	0	-100
50	80	0	-75	0	-100
80	120	0	-75	0	-100
120	150	0	-100	0	-120
150	180	0	-100	0	-120
180	250	0	-100	0	-120
250	315	0	-120	0	-150
315	400	0	-150	0	-200
400	500	0	-150	0	-200
500	630	0	-150	0	-200
630	800	0	-150	0	-200
800	1000	0	-300	0	-400
1000	1250	0	-300	0	-400

μ m

HRU Type

Table 9 Width tolerances of inner and outer ring

Type	B	
	Upper	Low
HRU42	0	-75
HRU66	0	-75
HRU85	0	-75
HRU124	0	-75
HRU148	0	-75
HRU178	0	-100
HRU228	0	-100
HRU297	0	-100
HRU445	0	-100

μ m

※Tolerances of B and B1 of RA type should be -0.12 ~ 0mm.

HRB Type

 Table 10 Radial clearances of HRB and HRE types (under preload) μm

Roller pitch circle diameter (Dpw/mm)		CC0		C0		C1	
Exceed	To	Min	Max	Min	Max	Min	Max
18	30	-8	0	0	15	15	35
30	50	-8	0	0	25	25	50
50	80	-10	0	0	30	30	60
80	120	-10	0	0	40	40	70
120	140	-10	0	0	40	40	80
140	160	-10	0	0	40	40	90
160	180	-10	0	0	50	50	100
180	200	-10	0	0	50	50	110
200	225	-10	0	0	60	60	120
225	250	-10	0	0	60	60	130
250	280	-15	0	0	80	80	150
280	315	-15	0	0	100	100	170
315	355	-15	0	0	110	110	190
355	400	-15	0	0	120	120	210
400	450	-20	0	0	130	130	230
450	500	-20	0	0	130	130	250
500	560	-20	0	0	150	150	280
560	630	-20	0	0	170	170	310
630	710	-20	0	0	190	190	350
710	800	-30	0	0	210	210	390
800	900	-30	0	0	230	230	430
900	1000	-30	0	0	260	260	480
1000	1120	-30	0	0	290	290	530
1120	1250	-30	0	0	320	320	580
1250	1400	-30	0	0	350	350	630

 Table 11 Radial clearance (under preload) μm

Roller pitch circle diameter (Dpw/mm)		CC0		C0	
Exceed	To	Min	Max	Min	Max
50	80	-8	0	0	15
80	120	-8	0	0	15
120	140	-8	0	0	15
140	160	-8	0	0	15
160	180	-10	0	0	20
180	200	-10	0	0	20
200	225	-10	0	0	20

HRU Type

 Table 12 Radial clearance of HRU type (under preload) μm

Type	CC0		C0	
	Starting torque (N · m)		Radial clearance(μm)	
	Min	Max	Min	Max
HRU42	0.1	0.5	0	25
HRU66	0.3	2.2	0	30
HRU85	0.4	3	0	40
HRU124	1	6	0	40
HRU148	1	10	0	40
HRU178	3	15	0	50
HRU228	5	20	0	60
HRU297	10	35	0	70
HRU445	20	55	0	100

※CC0 clearance of HRU type is controlled with the starting torque.
The starting torque does not include the seal resistance.

Mounting and fitting of crossed cylindrical roller bearing

Fitting of HRU type

There is basically no fitting requirement for HRU-type; however, if there is a mounting position accuracy requirement, h7 and H7 are recommended.

Fitting of HRB, HRE and HRA types

The fitting of HRB, HRE and HRA types should be selected from the table.

Fitting of HRB, HRE and HRA types

Radial clearance	Application conditions		Shaft	Support base
C0	Inner ring rotation load	Normal load	h5	H7
		Large impact load and torque	h5	H7
	Outer ring rotation load	Normal load	g5	Js7
		Large impact load and torque	g5	Js7
C1	Inner ring rotation load	Normal load	j5	H7
		Large impact load and torque	k5	Js7
	Outer ring rotation load	Normal load	g6	Js7
		Large impact load and torque	h5	K7

Note: For CC0 clearance fit, the mutual interference should be avoided; otherwise an excessive preload will be caused. When the CC0 clearance is used for a joint or rotating portion of a robot, the combination of g5 and H7 is recommended.

Notes in use of crossed roller bearings:

The two-divided inner or outer ring fixed with special rivets or bolts and nuts is inseparable, and should be directly mounted into the bearing base for use. Meanwhile, if the spacer holder assembling sequence is improper, it will have a great impact on the rotation performance of the bearing, so, the bearing can not be disassembled freely.

There is some deviation at the joint of inner or outer ring; before it is mounted into the bearing seat, the bolts to fix the inner or outer ring should be loosened to correct it with a plastic hammer. (the fixed rivets may be deformed with the bearing base deformation)

Do not apply any external force onto the fixed rivets or bolts during the mounting or removal.

Please note the size tolerances of the mounting parts, and press securely the inner or outer ring with the flange from the side.

Mounting steps for crossed roller bearing:

Mounting steps

The crossed roller bearing should be mounted with the following steps:

1. Inspection the parts before mounting :

Wash and clean the bearing seat or other mounting parts to remove the dirt and confirm that the burr on the parts has been removed.

2. When mounting, because the thin-walled bearing may be mounted tilt, it should be leveled and mounted by beating it evenly with a plastic hammer in the circumferential direction, until that it is contacted fully with the contact surface can be confirmed with the sound.

3. Side pressing flange mounting

(1) Place the side pressing flange in place, and shake it back and forth several times in the circumferential direction, in order to adjust the positions of the mounting bolts.

(2) Mount the pressing bolts. Tighten the bolts manually and make sure there is no deviation for the bolt holes.

(3) The pressing bolts can be tightened progressively and diagonally in 3~4 stages (as shown in the right figure). Slightly rotate the integrated inner or outer ring in the process to correct the two divided parts.

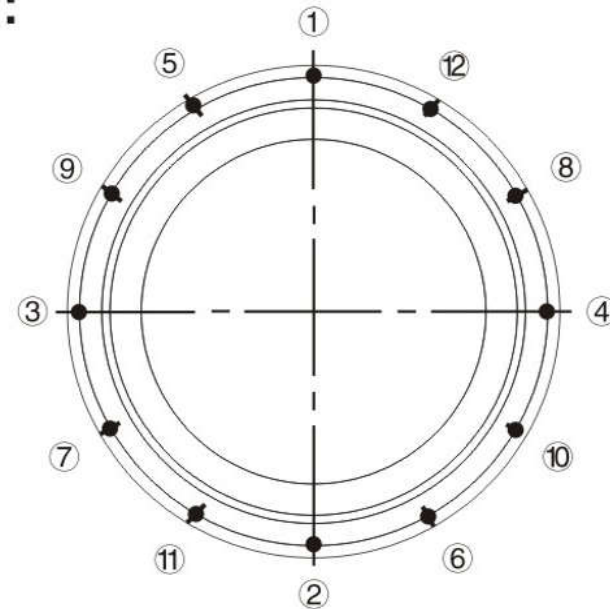

Design of the support seat and mounting flange

Because the crossed roller bearings have thin thickness and compact structure, the rigidity of support base and mounting flange must be considered. For two-divided outer ring, if the rigidity of support base and mounting flange bolts is insufficient, they can not balance the fixed outer and inner rings. Under the moment load, the bearing will be deformed, resulting in the uneven contact at the roller contact areas and the significant decrease of the bearing performances.

Support seat

As a reference, the thick wall of support seat should be above 60% of the bearing interface height.

Support seat wall thickness $T = \frac{D-d}{2} \times 0.6$ or greater (D: outer diameter of outer ring; d inner diameter of inner ring)

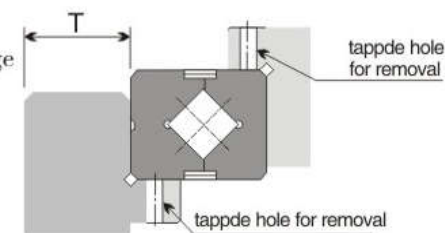

Disassembling screw hole

The assembling screw holes in inner and outer rings can be used to remove the bearing without causing damage. Do not press the inner during the outer ring disassembly and press the outer ring during the inner ring disassembly. In addition, the sizes fixed at the side should be referred to the shoulder sizes described in the table.

Mounting example

The crossed roller bearing mounting is exemplified shown on the right figure.

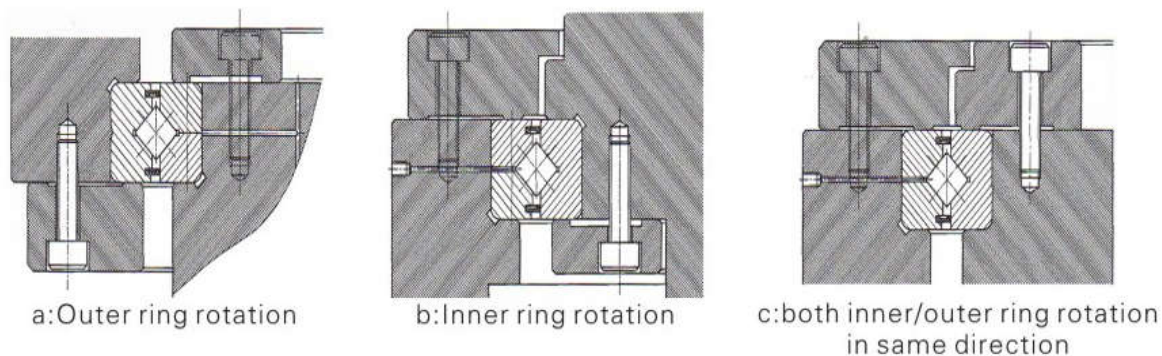

Mounting flange and bolts

The wall thickness of the mount flange (F) and the clearance of the flange portion (S) are shown in the left figure. In addition, although the more the number of mounting bolts are, the bearing is more stable, they should be configured evenly shown in following Table .

$$F = B \times 0.5 \sim B \times 1.2$$

$$H = B_{-0.1}^6$$

$$S = 0.5\text{mm}$$

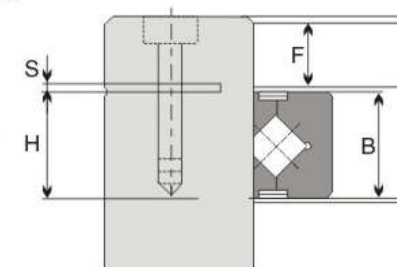

Even if the shaft and the support base are made of light alloy material, the mounting flange should still be made of steel-based material. The mounting bolts should be locked firmly with a torque wrench, to ensure no nay loosening, and the torque to lock the support base and the mounting flange made of common hard steel material is shown in following Table .

Number and size of mounting bolts

Unit: mm

Outer diameter of the outer ring		Number of bolts	Bolt size (Reference value)
Above	Or less		
–	100	8 or more	M3–M5
100	200	12 or more	M4–M8
200	500	16 or more	M5–M12
500	–	24 or more	M12 or greater

Bolt tightening torque

Unit: N.mm

Nominal size of screw	Tightening torque	Nominal size of screw	Tightening torque
M3	2	M10	70
M4	4	M12	120
M5	9	M16	200
M6	14	M20	390
M8	30	M22	530

Lubrication for crossed roller bearing

The crossed roller bearing has been filled with high quality 2# lithium grease, so it can be directly mounted for use. However, compared with common roller bearings, it has a smaller internal space, so the grease must be replenished periodically.

The grease should be replenished from the grease hole connected to the grease groove on the outer and inner rings. The grease replenishment interval is generally 6~12 months. The same grease must be replenished in all areas.

Meantime, when the grease is filled fully, the initial rotation torque will be increased in a short time due to the grease resistance; when the excess grease is spilled from the seal portions, it will soon be returned to the normal torque value.

HRA crossed cylindrical roller bearing

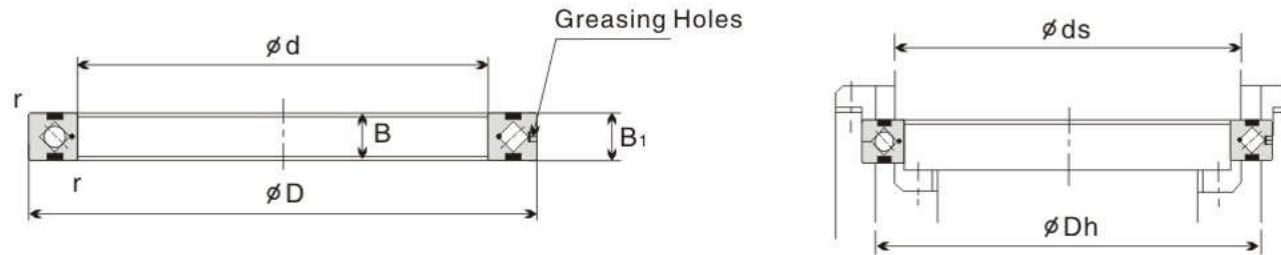

Type	Main sizes					Shoulder size		Basic rated load ratings(radial)		Mass
	Inner diameter	Outer diameter	Roller pitch circle diameter	Height	Chamfer			Cr	Cor	
	d	D	D _{pw}	B/B ₁	r _{min}	ds	D _h	kN	kN	kg
HRA5008	50	66	57	8	0.5	53.5	60.5	5.1	7.19	0.08
HRA6008	60	76	67	8	0.5	63.5	70.5	5.68	8.68	0.09
HRA7008	70	86	77	8	0.5	73.5	80.5	5.98	9.8	0.1
HRA8008	80	96	87	8	0.5	83.5	90.5	6.37	11.3	0.11
HRA9008	90	106	97	8	0.5	93.5	100.5	6.76	12.4	0.12
HRA10008	100	116	107	8	0.5	103.5	110.5	7.15	13.9	0.14
HRA11008	110	126	117	8	0.5	113.5	120.5	7.45	15	0.15
HRA12008	120	136	127	8	0.5	123.5	130.5	7.84	16.5	0.17
HRA13008	130	146	137	8	0.5	133.5	140.5	7.94	17.6	0.18
HRA14008	140	156	147	8	0.5	143.5	150.5	8.33	19.1	0.19
HRA15008	150	166	157	8	0.5	153.5	160.5	8.82	20.6	0.2
HRA16013	160	186	172	13	0.8	165	179	23.3	44.9	0.59
HRA17013	170	196	182	13	0.8	175	189	23.5	46.5	0.64
HRA18013	180	206	192	13	0.8	185	199	24.5	49.8	0.68
HRA19013	190	216	202	13	0.8	195	209	24.9	51.5	0.69
HRA20013	200	226	212	13	0.8	205	219	25.8	54.7	0.71

HRB crossed cylindrical roller bearing

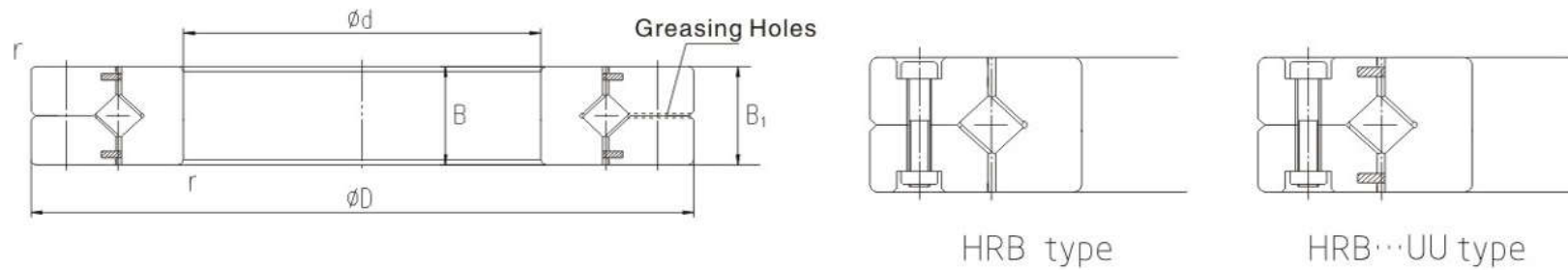

Type	Main sizes					Shoulder size		Basic load ratings (radial)		Mass
	Inner diameter	Outer diameter	Roller pitch circle diameter	Height	Chamfer			C_r	C_{or}	
	d	D	D_{pw}	B/B_1	r_{min}	d_s	D_h	kN	kN	
HRB3010	30	55	41.5	10	0.6	37	47	7.35	8.36	0.12
HRB3510	35	60	46.5	10	0.6	41	51.5	7.64	9.12	0.13
HRB4010	40	65	51.5	10	0.6	47.5	57.5	8.33	10.6	0.16
HRB4510	45	70	56.5	10	0.6	51	61.5	8.62	11.3	0.17
HRB5013	50	80	64	13	0.6	57.4	72	16.7	20.9	0.27
HRB6013	60	90	74	13	0.6	68	82	18	24.3	0.3
HRB7013	70	100	84	13	0.6	78	92	19.4	27.7	0.35
HRB8016	80	120	98	16	0.6	91	111	30.1	42.1	0.7
HRB9016	90	130	108	16	1	98	118	31.4	45.3	0.75

Type	Main sizes					Shoulder size		Basic rated load ratings(radial)		Mass
	Innerdiameter	Outer diameter	Roller pitch circle diameter	Height	Chamfer			C _r	C _{or}	
	d	D	D _{pw}	B/B ₁	r _{min}	d _s	D _h	kN	kN	kg
HRB10016	100	140	119.3	16	1	109	129	31.7	48.6	0.83
HRB10020		150	123	20	1	113	133	33.1	50.9	1.45
HRB11012	110	135	121.8	12	0.6	117	127	12.5	24.1	0.4
HRB11015		145	126.5	15	0.6	122	136	23.7	41.5	0.75
HRB11020		160	133	20	1	120	143	34	54	1.56
HRB12016	120	150	134.2	16	1.6	127	141	24.2	43.2	0.72
HRB12025		180	148.7	25	1.5	133	164	66.9	100	2.62
HRB13015	130	160	144.5	15	0.6	137	152	25	46.7	0.72
HRB13025		190	158	15	1.5	143	174	69.5	107	2.82
HRB14016	140	175	154.8	16	1	147	162	25.9	50.1	1
HRB14025		200	168	25	1.5	154	185	74.8	121	2.96
HRB15013	150	180	164	13	0.6	157	172	27	53.5	0.68
HRB15025		210	178	25	1.5	164	194	76.8	128	3.16
HRB15030		230	188	30	1.5	173	211	100	156	5.3
HRB16025	160	220	188.6	25	1.5	173	204	81.7	135	3.14
HRB17020	170	220	191	20	1.5	184	198	29	62.1	2.21
HRB18025	180	240	210	25	1.5	195	225	84	143	3.44
HRB19025	190	240	211.9	25	1	202	222	41.7	82.9	2.99
HRB20025	200	260	230	25	2	215	245	84.2	157	4
HRB20030		280	240	30	2	221	258	114	200	6.7
HRB20035		295	247.7	35	2	225	270	151	252	9.6

Type	Main sizes					Shoulder size		Basic rated load ratings(radial)		Mass
	Inner diameter	Outer diameter	Roller pitch circle diameter	Height	Chamfer			C _r	C _{or}	
	d	D	D _{pw}	B/B ₁	r _{min}	d _s	D _h	kN	kN	kg
HRB22025	220	280	250.1	25	2	235	265	92.3	171	4.1
HRB24025	240	300	269	25	2.5	256	281	68.3	145	4.5
HRB25025	250	310	277.5	25	2.5	265	290	69.3	150	5
HRB25030		330	287.5	30	2.5	269	306	126	244	8.1
HRB25040		355	300.7	40	2.5	275	326	195	348	14.8
HRB30025	300	360	328	25	2.5	315	340	76.3	178	5.9
HRB30035		395	345	35	2.5	322	368	183	367	13.4
HRB30040		405	351.6	40	2.5	326	377	212	409	17.2
HRB35020	350	400	373.4	20	2.5	363	383	54.1	143	3.9
HRB40035	400	480	400.3	35	2.5	422	459	156	370	14.5
HRB40040		510	453.4	40	2.5	428	479	241	531	23.5
HRB45025	450	500	474	25	1	464	484	61.7	182	6.6
HRB50025	500	550	524.2	25	1	514	534	65.5	201	7.3
HRB50040		600	548.8	40	2.5	526	572	239	607	26
HRB50050		625	561.6	50	2.5	536	587	267	653	41.7
HRB60040	600	700	650	40	3	627	673	264	721	29
HRB70045	700	815	753.5	45	3	731	777	281	836	46
HRB80070	800	950	868.1	70	4	836	900	468	1330	105
HRB90070	900	1050	969	70	4	937	1001	494	1490	120
HRB1000110	1000	1250	1114	110	5	1057	1171	1220	3220	360
HRB1250110	1250	1500	1365.8	110	5	1308	1423	1350	1970	440

HRE crossed cylindrical roller bearing

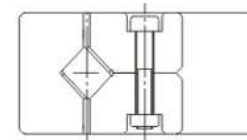
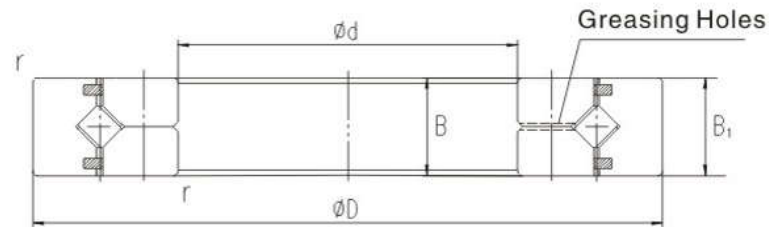

HRE type

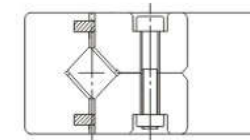

HRE...UU type

Type	Main sizes					Shoulder size		Basic rated load ratings(radial)		Mass
	Inner diameter	Outer diameter	Roller pitch circle diameter	Height	Chamfer			C_r	C_{or}	
	d	D	D_{pw}	B/B ₁	r_{min}	d_s	D_h	kN	kN	
HRE2008	20	36	29	8	0.5	23.5	30.5	3.23	3.1	0.04
HRE2508	25	41	34	8	0.5	28.5	35.5	3.63	3.83	0.05
HRE3010	30	55	43.5	10	0.6	37	47	7.35	8.36	0.12
HRE3510	35	60	48.5	10	0.6	41	51.5	7.64	9.12	0.13
HRE4010	40	65	53.5	10	0.6	47.5	58	8.33	10.6	0.16
HRE4510	45	70	58.5	10	0.6	51	61.5	8.62	11.3	0.17
HRE5013	50	80	66	13	0.6	57.5	72	16.7	20.9	0.27
HRE6013	60	90	76	13	0.6	68	82	18	24.3	0.3
HRE7013	70	100	86	13	0.6	78	92	19.4	27.7	0.35

Type	Main sizes					Shoulder size		Basic rated load ratings(radial)		Mass kg
	Inner diameter	Outer diameter	Roller pitch circle diameter	Height	Chamfer			C _r	C _{or}	
	d	D	D _{pw}	B/B ₁	r _{min}	d _s	D _h	kN	kN	
HRE8016	80	120	101.4	16	0.6	91	111	30.1	42.1	0.7
HRE9016	90	130	112	16	1	98	118	31.4	45.3	0.75
HRE10016	100	140	121.1	16	1	109	129	31.7	48.6	0.83
HRE10020		150	127	20	1	113	133	33.1	50.9	1.45
HRE11012	110	135	123.3	12	0.6	117	127	12.5	24.1	0.
HRE11015		145	129	15	0.6	122	136	23.7	41.5	0.75
HRE11020		160	137	20	1	120	140	34	54	1.56
HRE12016	120	150	136	16	0.6	127	141	12.2	43.2	0.72
HRE12025		180	152	25	1.5	133	164	66.9	100	2.62
HRE13015	130	160	146	15	0.6	137	152	25	46.7	0.72
HRE13025		190	162	25	1.5	143	174	69.5	107	2.82
HRE14016	140	175	160	16	1	147	162	25.9	50.1	1
HRE14025		200	172	25	1.5	154	185	74.8	121	2.96
HRE15013	150	180	166	13	0.6	158	172	27	53.5	0.68
HRE15025		210	182	25	1.5	164	194	76.8	128	3.16
HRE15030		230	192	30	1.5	173	210	100	156	5.3
HRE16025	160	220	192	25	1.5	173	204	81.7	135	3.14
HRE17020	170	220	196.1	20	1.5	184	198	29	62.1	2.21
HRE18025	180	240	210	25	1.5	195	225	84	143	3.44
HRE19025	190	240	219	25	1	202	222	41.7	82.9	2.99

Type	Main sizes					Shoulder size		Basic rated load ratings(radial)		Mass kg
	Inner diameter	Outer diameter	Roller pitch circle diameter	Height	Chamfer			C _r	C _{or}	
	d	D	D _{pw}	B/B ₁	r _{min}	d _s	D _h	kN	kN	
HRE20025	200	260	230	25	2	215	245	84.2	157	4
HRE20030		280	240	30	2	221	258	114	200	6.7
HRE20035		295	247.7	35	2	225	270	151	252	9.6
HRE22025	220	280	250.1	25	2	235	265	92.3	171	4.1
HRE24025	240	300	272.5	25	2.5	256	281	68.3	145	4.5
HRE25025	250	310	280.9	25	2.5	268	293	69.3	150	5
HRE25030		330	287.5	30	2.5	269	306	126	244	8.1
HRE25040		355	300.7	40	2.5	275	326	195	348	14.8
HRE30025	300	360	332	25	2.5	319	344	75.5	178	5.94
HRE30035		395	345	35	2.5	322	368	183	367	13.4
HRE30040		405	351.6	40	2.5	326	377	212	409	17.2
HRE35020	350	400	376.6	20	2.5	363	383	54.1	143	3.9
HRE40035	400	480	440.3	35	2.5	422	459	156	370	14.5
HRE40040		510	453.4	40	2.5	428	479	241	531	23.5
HRE45025	450	500	476.6	25	1	464	484	61.7	182	6.6
HRE50025	500	550	526.6	25	1	514	534	65.5	201	7.3
HRE50040		600	548.8	40	2.5	526	572	239	607	26
HRE50050		625	561.6	50	2.5	536	587	267	653	41.7
HRE60040	600	700	650	40	3	627	673	264	721	29

HRU crossed cylindrical roller bearing

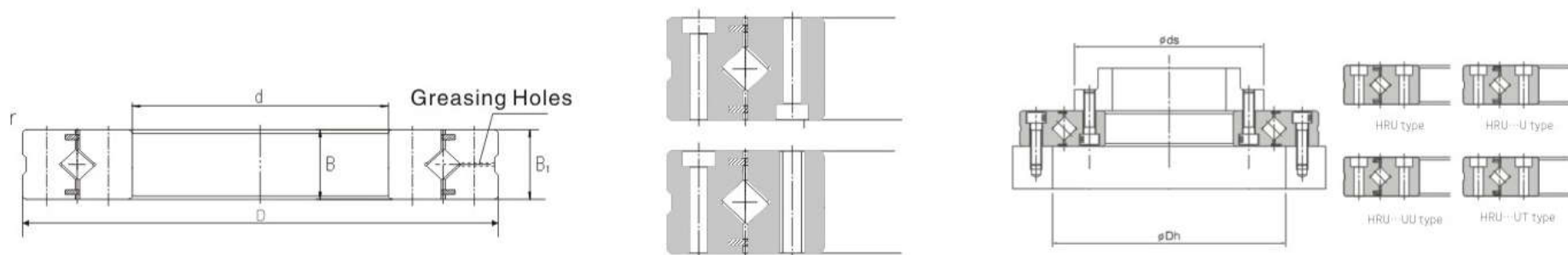

Type	Main sizes					Shoulder size		Basic rated load ratings(radial)		Mass kg
	Inner diameter	Outer diameter	Roller pitch circle diameter	Height	Chamfer			C_r	C_{or}	
	d	D	D_{pw}	B/B ₁	r _{min}	d _s	D _h	kN	kN	
HRU42	20	70	41.5	12	0.6	37	47	7.35	8.35	0.29
HRU66	35	95	66	15	0.6	59	74	17.5	22.3	0.62
HRU85	55	120	85	15	0.6	79	93	20.3	29.5	1
HRU 124(G)	80	165	124	22	1	114	134	33.1	50.9	2.6
HRU 124X										
HRU 148(G)	90	210	147.5	25	1.5	133	162	49.1	76.8	4.9
HRU 148X										
HRU 178(G)	115	240	178	28	1.5	161	195	80.3	135	6.8
HRU 178X										
HRU 228(G)	160	295	227.5	35	2	208	246	104	173	11.4
HRU 228X										
HRU 297(G)	210	380	297.3	40	2.5	272	320	156	281	21.3
HRU 297X										
HRU 445(G)	350	540	445.4	45	2.5	417	473	222	473	35.4
HRU 445X										

Crossed tapered roller bearing

Structure and characteristics of crossed tapered roller bearing

The crossed tapered roller bearing has two sets of raceways and rollers, combined and staggered with each other at a right angle. Compared with the crossed cylindrical roller bearing, the differences are that its rolling elements are the tapered rollers, the bearing section height is equivalent to the single bearing and the bearing base is simplified. The large cone angle and cone design allows that the overall effective span of bearing is up to several times of its own width. Therefore, this type of bearing can carry high overturning moment, and is widely used in the turrets, large hobbing machines, industrial robots, high speed vertical lathes, accuracy circular indexing tables, vertical boring machines, grinding machine bench spindles and etc.

Applications

Accuracy rotary indexing tables of machine	Large radio and optical telescopes
Central shaft	Accuracy rotary tables
Vertical and horizontal boring machines	Rotary cameras
Rotating bogies	Medical devices
Vertical grinding machines	Steering pivots and continuous casting machines
Welding brackets	Measuring instruments
Rotary surface grinders	Highly restricted pivots
Mooring buoys of large tanker	IC manufacturing apparatus
Large hobbing machines	Microscope benches
Slewing assembly angle tools	
Gun and radar turrets	
Industrial robots	

Design and structural characteristics

- ◆ The line contact between the raceway and the rollers can provide maximum rotation accuracy, high stability and greater tilting rigidity.
- ◆ The adjustable preload design can extend the bearing life, increase the maximum rigidity and provide the minimum runout.
- ◆ The nylon spacer has a lower inertia and smaller operation torque.
- ◆ It has the high rotation accuracy and rigidity and can substantially reduce the material cost.
- ◆ The angle and tapered geometry of bearing allows that its effective span is up to several times of its own width.

Crossed tapered roller bearing

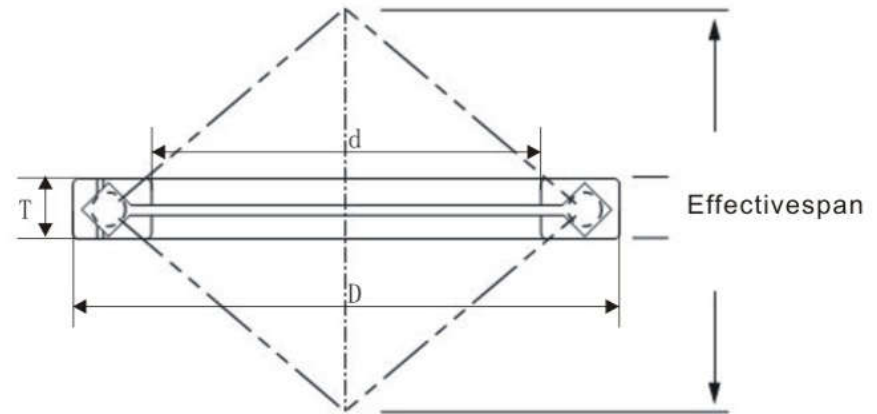

Type	Main sizes				Basic load ratings(radial)		Limiting Speed	Mass kg
	Inner diameter	Outer diameter	Height	Chamfer	C_r	C_{or}	Oil	
	d	D	T	r_{min}	kN	kN	r_{min}	
HXR496051	203.2	279.4	31.75	1.5	41	49.2	800	6.5
HXR678052	330.2	457.2	63.5	3	80	98.4	620	35
HXR766051	457.2	609.6	63.5	3	106	133	520	51
HXR820060	580	760	80	5	106	209	300	100
HXR855053	685.8	914.4	79.375	3	180	224	260	150
HXR882055	901.7	1117.6	82.55	3	225	297	200	185
HXR889058	1028.7	1327.15	114.3	3	283	374	160	400
HXR897051	1549.4	1828.8	101.6	3	326	489	80	500
HXR637050	300	400	37	1.5	47.2	60	720	13
HXR652050	310	425	45	2.5	61.6	76.5	640	20
HXR699050	370	495	50	3	70.2	89.2	600	30

Note: For ease of calculation, the bearing load ratings provided in the above table is based on 3000h of operations at the speed of 500 r/min, referred as L_{10} life; but the maximum speed of bearing is dependent on the bearing size and load, and the speed may be lower than 500 r/min.

Application fields



Aviation



Aerospace



Radar communication



Industrial robots



CNC machine tools



Indexing plate



Turntable



Rotary tables



Polishing equipment

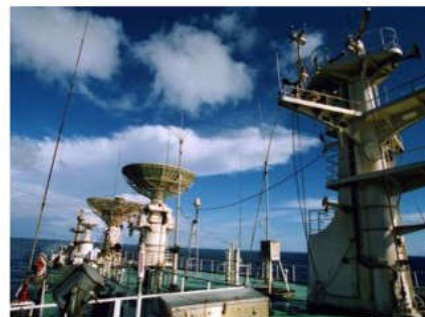

Ocean measurement and control



Printing equipment

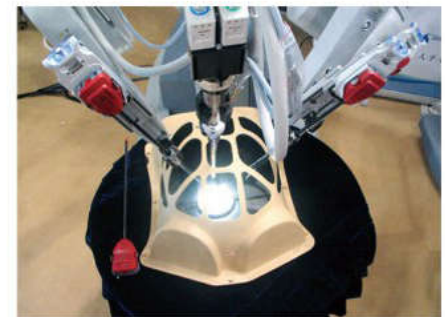

Medical equipment

Crossed roller bearings applied in the robot industry

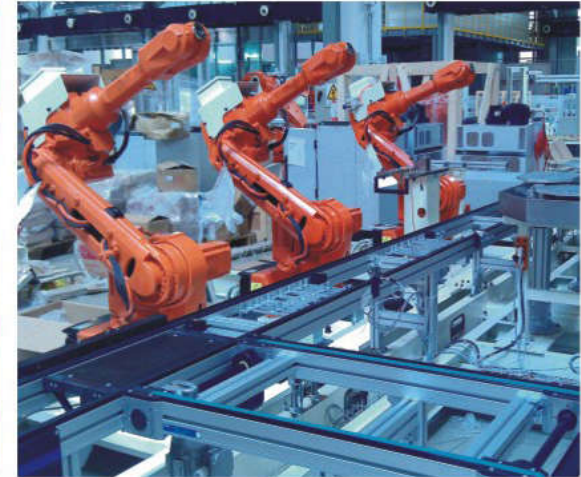
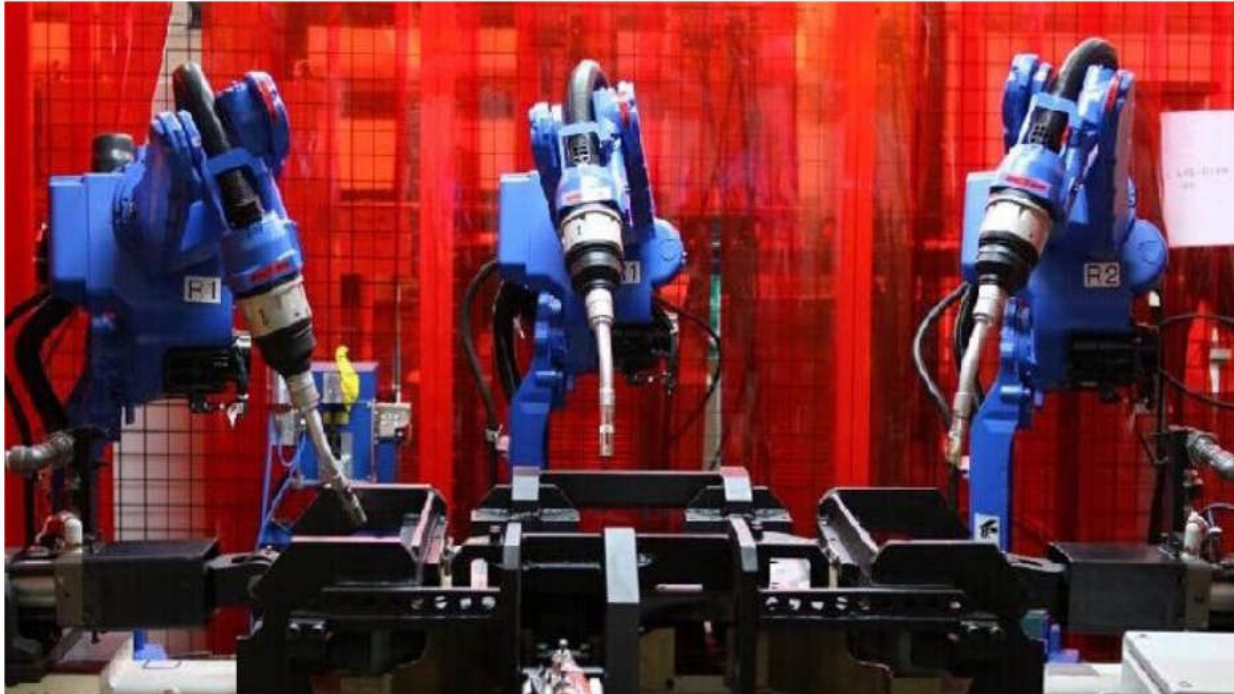

Handling robot



Medical equipment robot



Welding robot



Cutting robot



Palletizing robot



LUOYANG HUIGONG BEARING TECHNOLOGY CO., LTD.

ADD: NO.999, Guanlin Road, Luolong District, Luoyang City,
Henan province, China

Code: 471023

Tel: +86-379-65793878

Fax: +86-379-65793877

E-mail: sale@chg-bearing.com